

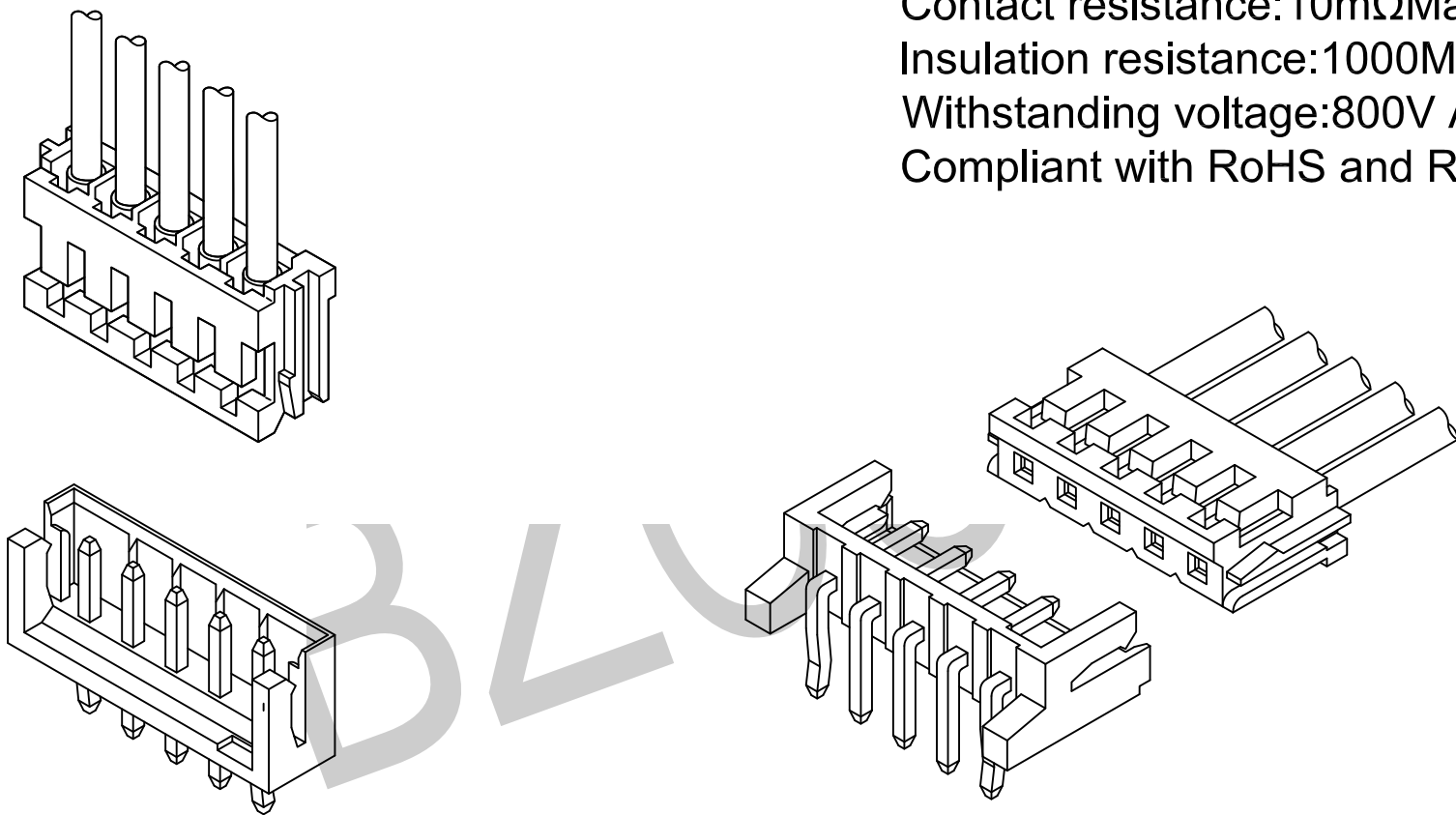

Current rating:3A AC,DC
 Voltage rating:250V AC,DC
 Temperature range:-40°C~+105°C
 Contact resistance:10mΩMax.
 Insulation resistance:1000MΩMin.
 Withstanding voltage:800V AC/minute
 Compliant with RoHS and REACH



TOLERANCE UNLESS OTHERWISE SPECIFIED				东莞市柏洲电子有限公司 Dongguan BzooC Electronics, Ltd	
.X± 0.35	X.*± 1.5*	APR. AX.T	TITLE: W250-04 TYPE WAFER		
.XX± 0.25	.X*± 1.0*	CHK. Y.L	PART NO.		
.XXX± 0.15	.XX*± 0.5*	DRA. Y.L	PROJ.	UNITS. MM	SCALE: 1:1
A0	FIRST RELEASE	Y.L	2019.06.21	CUSTOMER DRAWING	
REV.	ECN. NO.	APR.	DATE	SHEET. 1 / 1	



Current rating:3A AC,DC
 Voltage rating:250V AC,DC
 Temperature range:-40°C~+105°C
 Contact resistance:10mΩMax.
 Insulation resistance:1000MΩMin.
 Withstanding voltage:800V AC/minute
 Material:Pin:Brass/Tin over Nickel
 Insulator:Nylon 66,UL94V-0

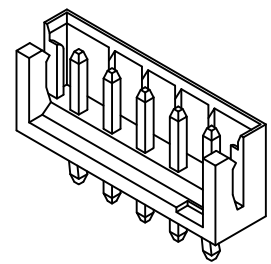
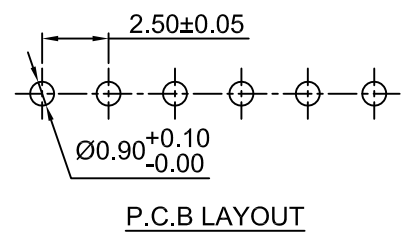
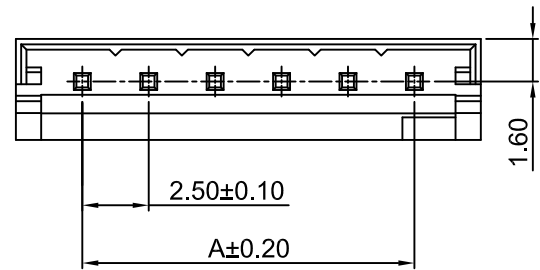

PIN NO.	Dimensions	
	A	B
2P	2.50	7.50
3P	5.00	10.00
4P	7.50	12.50
5P	10.00	15.00
6P	12.50	17.50
7P	15.00	20.00
08P	17.50	22.50
09P	20.00	25.00
10P	22.50	27.50
11P	25.00	30.00
12P	27.50	32.50
13P	30.00	35.00
14P	32.50	37.50
15P	35.00	40.00

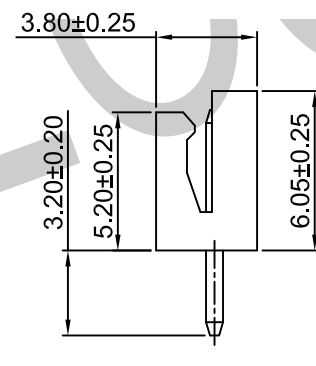
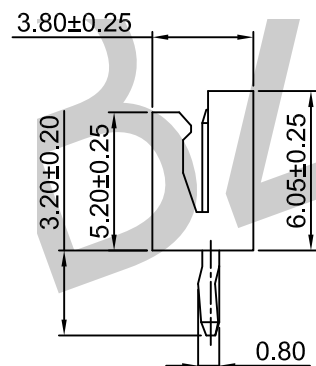
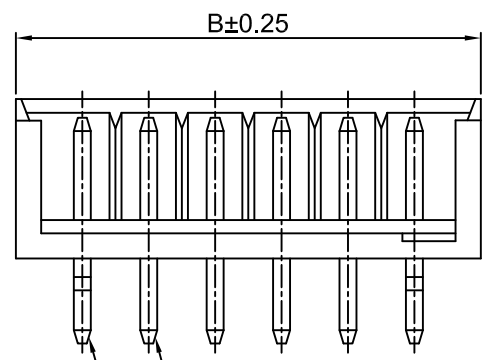

WAFER W 250-040-1XX-WV1-SN-C-P-WE-000
 250:间距2.5MM
 04:WAFER TYPE4
 0:UL94V-0
 PIN:
 102:1*2P
 103:1*3P

 115:1*15P
 WV1:180°带K脚
 WV2:180°
 流水码
 WE:白色
 P:袋装
 C:PA66
 SN:镀锡

Circuit 1

WV1

WV2

AO	FIRST RELEASE	Y.L	2019.06.21
REV.	ECN. NO.	APR.	DATE

TOLERANCE UNLESS OTHERWISE SPECIFIED		东莞市柏洲电子有限公司 Dongguan BzooC Electronics, Ltd	
.X± 0.35	X.*± 1.5'	APR. AX.T	TITLE: 2.50MM PITCH HOUSING TYPE4
.XX± 0.25	.X*± 1.0'	CHK. Y.L	PART NO.
.XXX± 0.15	.XX*± 0.5'	DRA. Y.L	PROJ. UNITS. MM SCALE. 1:1 CUSTOMER DRAWING SHEET. 1/1



Current rating:3A AC,DC
 Voltage rating:250V AC,DC
 Temperature range:-40°C~+105°C
 Contact resistance:10mΩMax.
 Insulation resistance:1000MΩMin.
 Withstanding voltage:800V AC/minute
 Material:Pin:Brass/Tin over Nickel
 Insulator:Nylon 66,UL94V-0

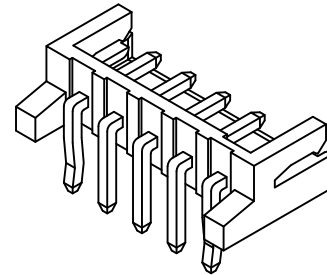
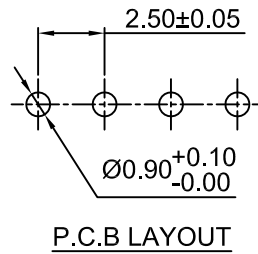
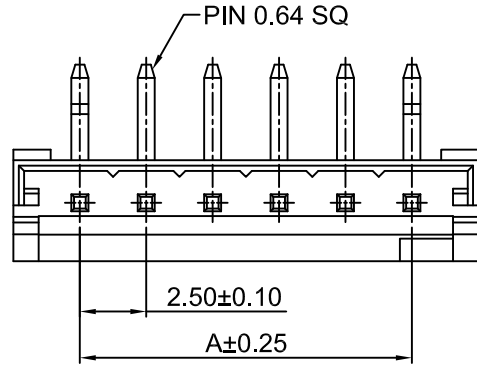

PIN NO.	Dimensions	
	A	B
2P	2.50	7.50
3P	5.00	10.00
4P	7.50	12.50
5P	10.00	15.00
6P	12.50	17.50
7P	15.00	20.00
08P	17.50	22.50
09P	20.00	25.00
10P	22.50	27.50
11P	25.00	30.00
12P	27.50	32.50
13P	30.00	35.00
14P	32.50	37.50
15P	35.00	40.00

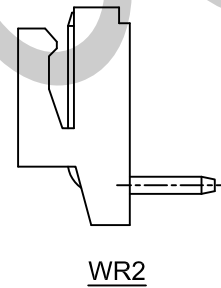
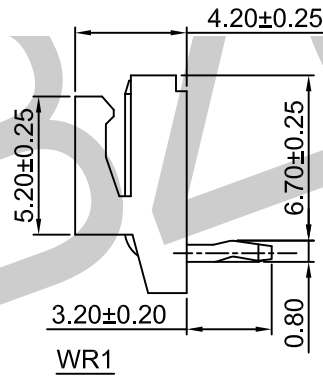
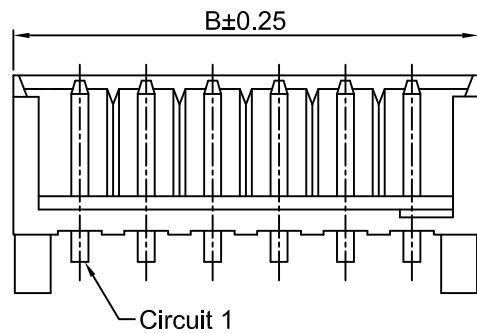

WAFER W 250-040-1XX-WR1-SN-C-P-WE-000
 250:间距2.5MM
 04:WAFER TYPE4
 0:UL94V-0
 PIN:
 102:1*2P
 103:1*3P

 120:1*20P

流水码
 WE:白色
 P: 袋装
 C:PA66
 SN:镀锡

WR1:90°带K脚
 WR2:90°

TOLERANCE UNLESS OTHERWISE SPECIFIED				东莞市柏洲电子有限公司 Dongguan BzooC Electronics, Ltd	
.X± 0.35	X.*± 1.5*	APR. AX.T	TITLE: 2.50MM PITCH 90° WAFER TYPE4		
.XX± 0.25	.X*± 1.0*	CHK. Y.L	PART NO.		
.XXX± 0.15	.XX*± 0.5*	DRA. Y.L	PROJ.	UNITS. MM	SCALE: 1:1
A0	FIRST RELEASE	Y.L	2019.06.21	CUSTOMER DRAWING	
REV.	ECN. NO.	APR.	DATE	SHEET. 1 / 1	



Current rating:3A AC,DC
 Voltage rating:250V AC,DC
 Temperature range:-40°C~+105°C
 Contact resistance:10mΩMax.
 Insulation resistance:1000MΩMin.
 Withstanding voltage:800V AC/minute
 Material:Phosphor Bronze
 Wire Range:AWG#22-#30
 Insulation O.D.:1.90mm(max)
 Qty/reel:10,000 PCS

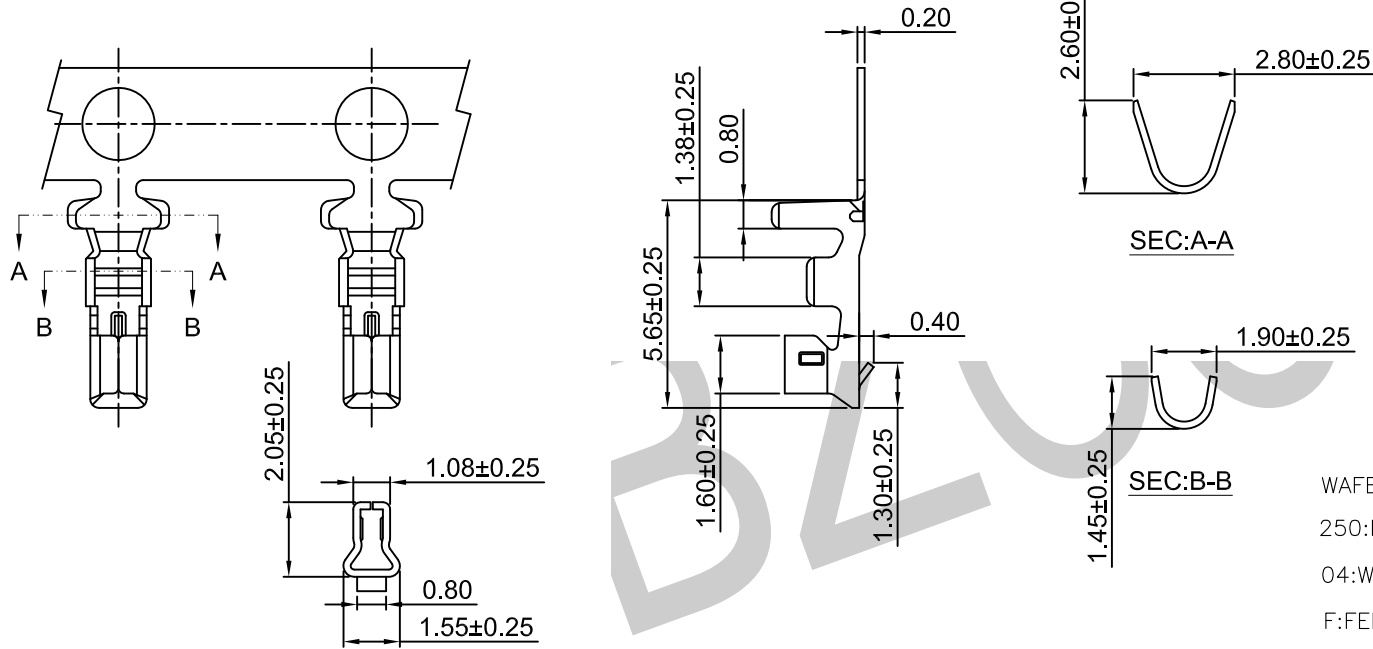

W 250-04F-PDJ-SN-000 SERIAL NO.
 250:PITCH 2.5MM
 04:WAFER TYPE4
 F:FEMALE TERMINAL
 P:PHOSPHOR BRONZE
 SN:TIN PLATING
 GF:GOLD PLATING
 DJ:LOW. PIN

A0	FIRST RELEASE	Y.L	2019.06.21
REV.	ECN. NO.	APR.	DATE

TOLERANCE UNLESS OTHERWISE SPECIFIED		BZOOC 东莞市柏洲电子有限公司 Dongguan BzooC Electronics, Ltd	
.X± 0.35	X.*± 1.5*	APR. AX.T	TITLE: 2.50MM PITCH CRIMP TERMINAL TYPE4
.XX± 0.25	.X*± 1.0*	CHK. Y.L	PART NO.
.XXX± 0.15	.XX*± 0.5*	DRA. Y.L	PROJ.
		UNITS. MM	SCALE: 1:1
		CUSTOMER DRAWING	
		SHEET. 1 / 1	



Current rating:3A AC,DC
 Voltage rating:250V AC,DC
 Temperature range:-40°C~+105°C
 Contact resistance:10mΩMax.
 Insulation resistance:1000MΩMin.
 Withstanding voltage:800V AC/minute
 Material:Nylon 66,UL94V-0

PIN NO.	Dimensions	
	A	B
2P	2.50	7.00
3P	5.00	9.50
4P	7.50	12.00
5P	10.00	14.50
6P	12.50	17.00
7P	15.00	19.50
8P	17.50	22.00
9P	20.00	24.50
10P	22.50	27.00
11P	25.00	29.50
12P	27.50	32.00
13P	30.00	34.50
14P	32.50	37.00
15P	35.00	39.50

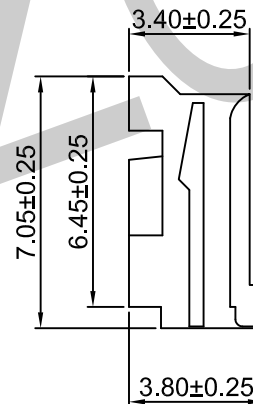
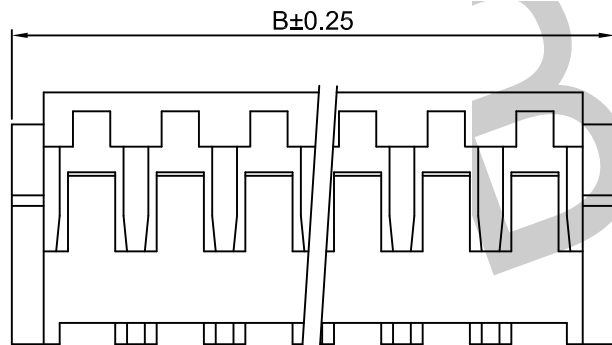
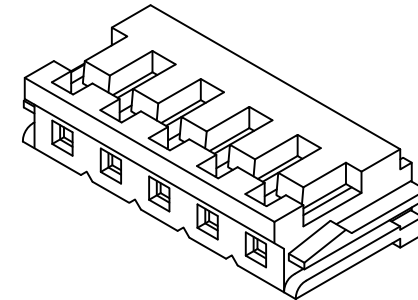
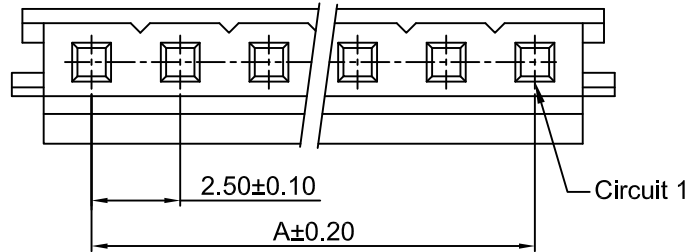

WAFER W 250-040-1XX-HM-WE-C-P-000 SERIAL NO.
 250:间距2.5MM PACKING:BAG
 04:WAFER TYPE4 C:PA66
 0:UL94V-0 WE:WHITE
 PIN NO.: HM:MALE HOUSING
 102:1*2P
 103:1*3P
 ...
 115:1*15P

TOLERANCE UNLESS OTHERWISE SPECIFIED		BZOOC 东莞市柏洲电子有限公司 Dongguan BzooC Electronics, Ltd	
.X± 0.35	X.*± 1.5*	APR. AX.T	TITLE: 2.50MM PITCH HOUSING TYPE4
.XX± 0.25	.X*± 1.0*	CHK. Y.L	PART NO.
.XXX± 0.15	.XX*± 0.5*	DRA. Y.L	PROJ.
A0	FIRST RELEASE	Y.L	2019.06.21
REV.	ECN. NO.	APR.	DATE
UNITS: MM		SCALE: 1:1	SHEET. 1 / 1
CUSTOMER DRAWING			

A0	FIRST RELEASE	Y.L	2019.06.21
REV.	ECN. NO.	APR.	DATE