

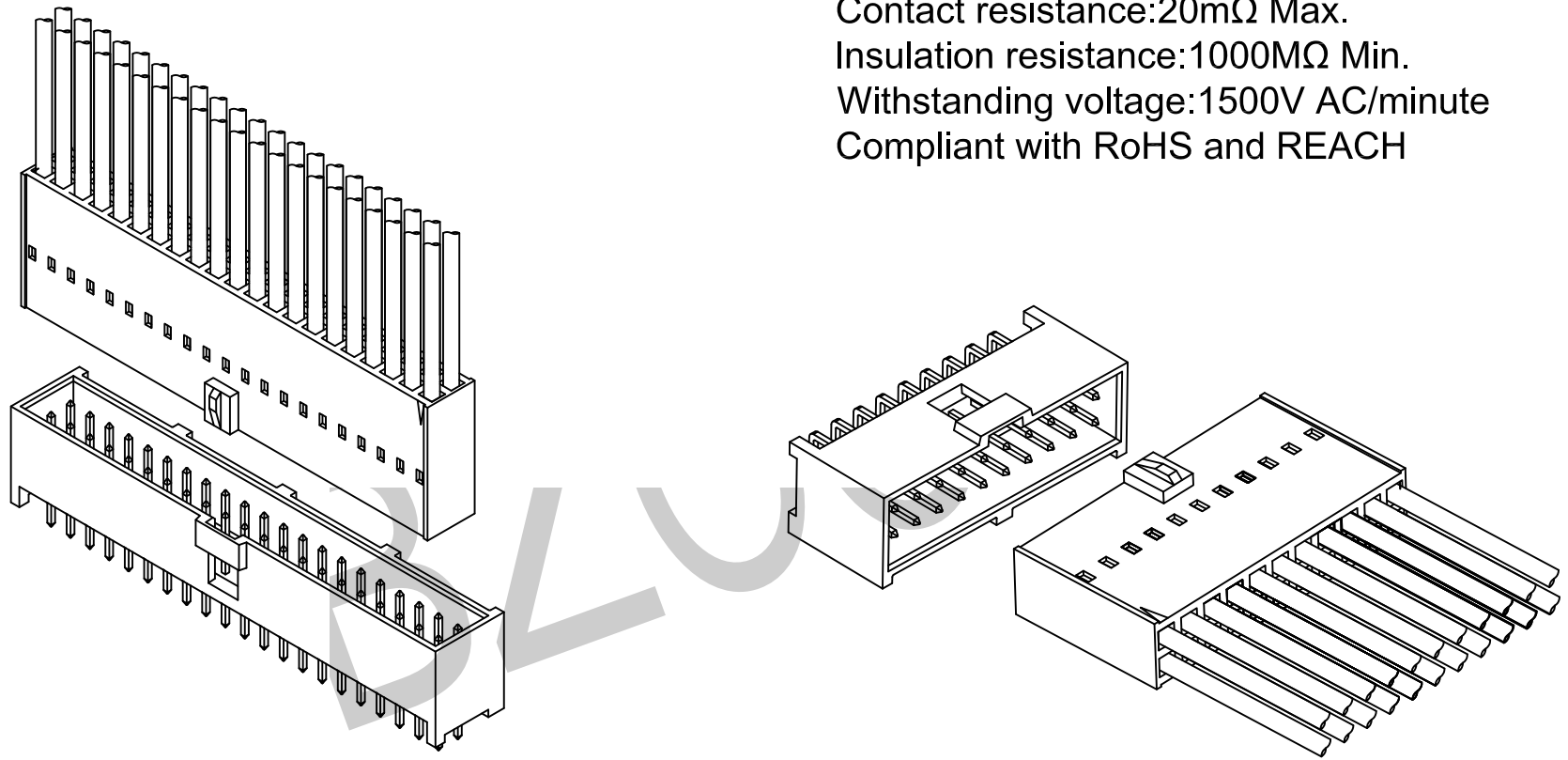

Current rating:3A AC,DC
 Voltage rating:250V AC,DC
 Temperature range:-40°C~+105°C
 Contact resistance:20mΩ Max.
 Insulation resistance:1000MΩ Min.
 Withstanding voltage:1500V AC/minute
 Compliant with RoHS and REACH



A0	FIRST RELEASE	Y.L	2019.06.21
REV.	ECN. NO.	APR.	DATE

TOLERANCE UNLESS OTHERWISE SPECIFIED		东莞市柏洲电子有限公司 Dongguan BzooC Electronics, Ltd	
.X± 0.35	X'± 1.5'	APR. AX.T	TITLE: 2.54MM PITCH CRIMP TERMINAL TYPE1
.XX± 0.25	.X'± 1.0'	CHK. Y.L	PART NO.
.XXX± 0.15	.XX'± 0.5'	DRA. Y.L	PROJ. UNITS. MM SCALE: 1:1 SHEET. 1 / 1 CUSTOMER DRAWING



PIN NO.	Dimensions		
	A	B	C
2X03P	5.08	9.96	8.12
2X04P	7.62	12.50	10.66
2X05P	10.16	15.04	13.20
2X06P	12.70	17.58	15.74
2X07P	15.24	20.12	18.28
2X08P	17.78	22.66	20.82
2X09P	20.32	25.20	23.36
2X10P	22.86	27.74	25.90
2X11P	25.40	30.28	28.44
2X12P	27.94	32.82	30.98
2X13P	30.48	35.36	33.52
2X14P	33.02	37.09	36.06
2X15P	35.56	40.44	38.60
2X16P	38.10	42.98	41.14
2X17P	40.64	45.52	43.68
2X18P	43.18	48.06	46.22
2X19P	45.72	50.60	48.76
2X20P	48.26	53.14	51.30
2X21P	50.80	55.68	53.84
2X22P	53.34	58.22	56.38
2X23P	55.88	60.76	58.92
2X24P	58.42	63.30	61.46
2X25P	60.96	65.84	64.00
2X26P	63.50	68.38	66.54
2X27P	66.04	70.92	69.08
2X28P	68.58	73.46	71.62
2X29P	71.12	76.00	74.16
2X30P	73.66	78.54	76.70
2X31P	76.20	81.08	79.24
2X32P	78.74	83.62	81.78

Current rating:3A AC,DC
 Voltage rating:250V AC,DC
 Temperature range:-40°C~+105°C
 Contact resistance:20mΩ Max.
 Insulation resistance:1000MΩ Min.
 Withstanding voltage:1500V AC/minute
 Material:Pin:Brass/Gold over Nickel
 Insulator:PBT15%GF,UL94V-0

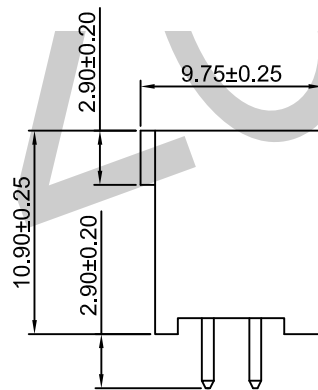
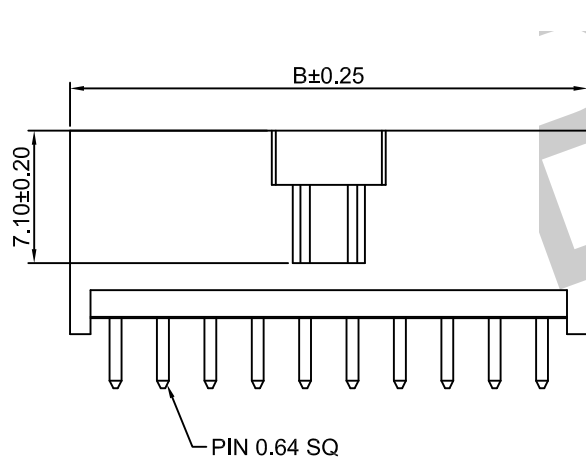
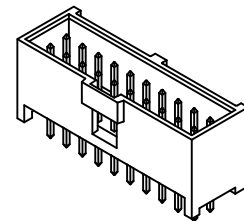
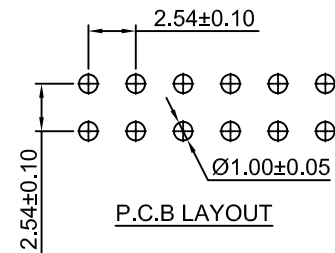
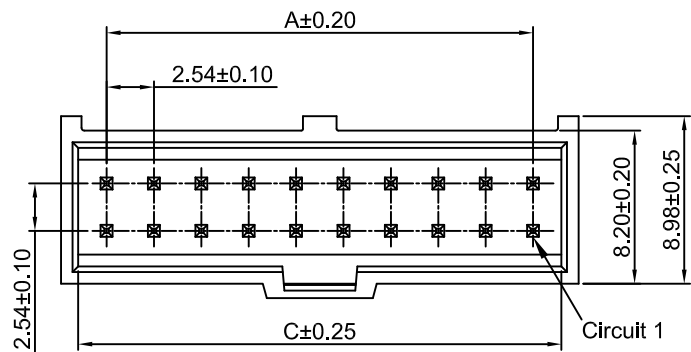

WAFER W 254-020-2XX-WV-XX-A-P-BK-000
 254:间距2.54MM
 02:WAFER TYPE2
 0:UL94V-0
 PIN NO.:
 203:2*3P
 204:2*4P
 ...
 232:2*32P

流水码
 BLACK
 P: 袋装
 A:PBT
 SN:镀锡
 GF:镀金

WV:180°

TOLERANCE UNLESS OTHERWISE SPECIFIED		东莞市柏洲电子有限公司 Dongguan BzooC Electronics, Ltd	
.X± 0.35	X.*± 1.5*	APR. AX.T	TITLE: 2.54MM PITCH 180° BOX HEADER TYPE1
.XX± 0.25	.X.*± 1.0*	CHK. Y.L	PART NO.
.XXX± 0.15	.XX.*± 0.5*	DRA. Y.L	PROJ. UNITS. MM SCALE: 1:1 SHEET. 1 / 1 CUSTOMER DRAWING

A0	FIRST RELEASE	Y.L	2019.06.21
REV.	ECN. NO.	APR.	DATE



PIN NO.	Dimensions		
	A	B	C
2X03P	5.08	9.96	8.12
2X04P	7.62	12.50	10.66
2X05P	10.16	15.04	13.20
2X06P	12.70	17.58	15.74
2X07P	15.24	20.12	18.28
2X08P	17.78	22.66	20.82
2X09P	20.32	25.20	23.36
2X10P	22.86	27.74	25.90
2X11P	25.40	30.28	28.44
2X12P	27.94	32.82	30.98
2X13P	30.48	35.36	33.52
2X14P	33.02	37.09	36.06
2X15P	35.56	40.44	38.60
2X16P	38.10	42.98	41.14
2X17P	40.64	45.52	43.68
2X18P	43.18	48.06	46.22
2X19P	45.72	50.60	48.76
2X20P	48.26	53.14	51.30
2X21P	50.80	55.68	53.84
2X22P	53.34	58.22	56.38
2X23P	55.88	60.76	58.92
2X24P	58.42	63.30	61.46
2X25P	60.96	65.84	64.00
2X26P	63.50	68.38	66.54
2X27P	66.04	70.92	69.08
2X28P	68.58	73.46	71.62
2X29P	71.12	76.00	74.16
2X30P	73.66	78.54	76.70
2X31P	76.20	81.08	79.24
2X32P	78.74	83.62	81.78

Current rating:3A AC,DC
 Voltage rating:250V AC,DC
 Temperature range:-40°C~+105°C
 Contact resistance:20mΩ Max.
 Insulation resistance:1000MΩ Min.
 Withstanding voltage:1500V AC/minute
 Material:Pin:Brass/Gold over Nickel
 Insulator:PBT15%GF,UL94V-0

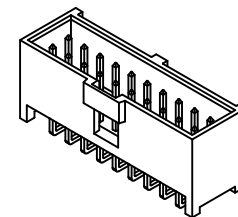
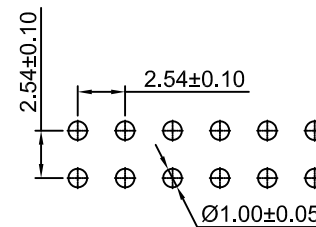
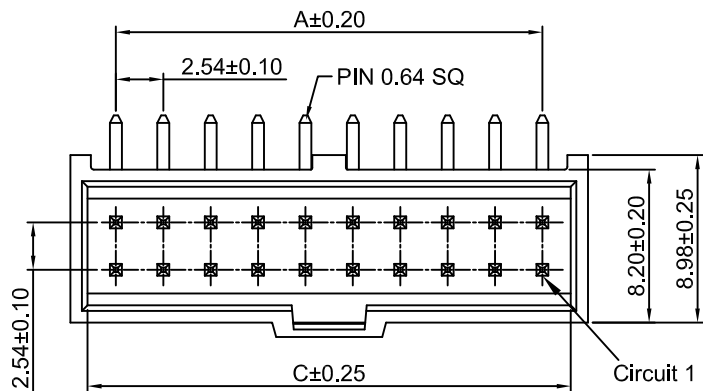

P.C.B LAYOUT

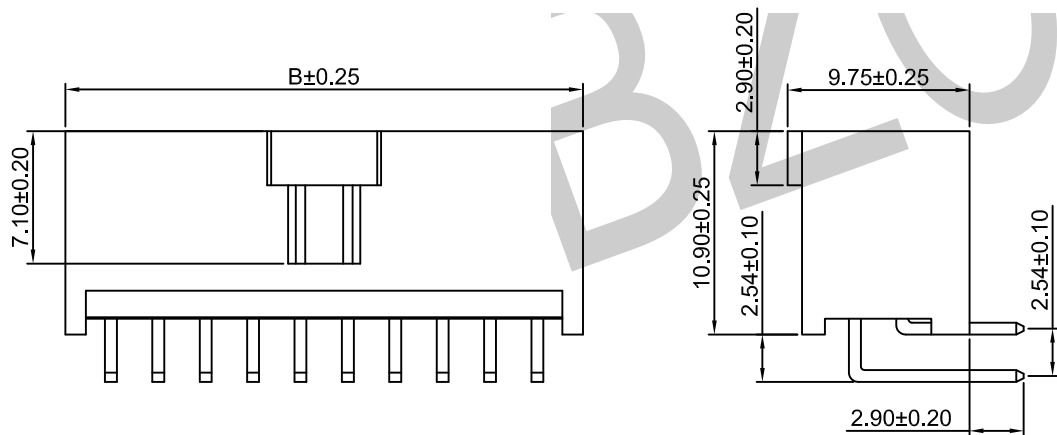

WAFER W 254-020-2XX-WR-XX-A-P-BK-000
 254:间距2.54MM
 02:WAFER TYPE2
 0:UL94V-0
 PIN NO.:
 203:2*3P
 204:2*4P
 ...
 232:2*32P

流水码
 BLACK
 P: 袋装
 A:PBT
 SN:镀锡
 GF:镀金

WR:90°

TOLERANCE UNLESS OTHERWISE SPECIFIED		BZOOC 东莞市柏洲电子有限公司 Dongguan BzooC Electronics, Ltd	
.X± 0.35	X.*± 1.5*	APR. AX.T	TITLE: 2.54MM PITCH 90° BOX HEADER TYPE1
.XX± 0.25	.X.*± 1.0*	CHK. Y.L	PART NO.
.XXX± 0.15	.XX.*± 0.5*	DRA. Y.L	PROJ. UNITS. MM SCALE: 1:1 SHEET. 1 / 1
REV.	ECN. NO.	APR.	DATE

A0	FIRST RELEASE	Y.L	2019.06.21
REV.	ECN. NO.	APR.	DATE



Current rating:3A AC,DC
 Voltage rating:250V AC,DC
 Temperature range:-40°C~+105°C
 Contact resistance:20mΩ Max.
 Insulation resistance:1000MΩ Min.
 Withstanding voltage:1500V AC/minute
 Material:Phosphor Bronze
 Wire Range:AWG#22-#24
 Insulation O.D.:1.60mm(max)
 Qty/reel:15,000 PCS

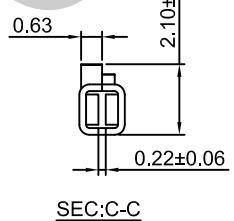
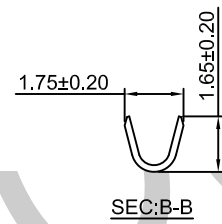
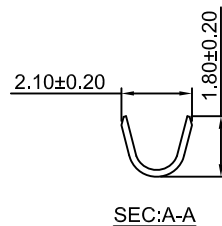
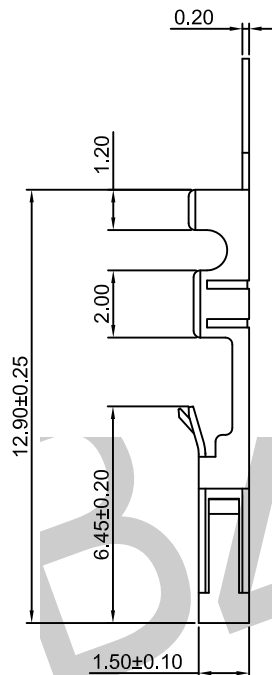
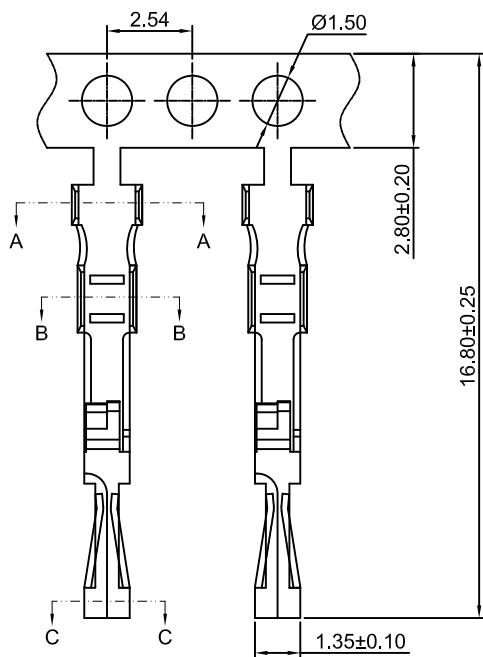

WAFER W 254-02F-PDJ-SN-000 SERIAL NO.
 254:PITCH 2.54MM
 02:WAFER TYPE2
 F:FEMALE TERMINAL
 P:PHOSPHOR BRONZE
 SN:TIN PLATING
 GF:GOLD PLATING
 DJ:LOW. PIN

AO	FIRST RELEASE	Y.L	2019.06.21
REV.	ECN. NO.	APR.	DATE

TOLERANCE UNLESS OTHERWISE SPECIFIED		东莞市柏洲电子有限公司 Dongguan BzooC Electronics, Ltd	
.X± 0.35	X.*± 1.5*	APR. AX.T	TITLE: 2.54MM PITCH CRIMP TERMINAL TYPE1
.XX± 0.25	.X*± 1.0*	CHK. Y.L	PART NO.
.XXX± 0.15	.XX*± 0.5*	DRA. Y.L	PROJ. UNITS. MM SCALE: 1:1 SHEET. 1 / 1 CUSTOMER DRAWING



PINNO.	Dimensions	
	A	B
2X03P	5.08	7.59
2X04P	7.62	10.13
2X05P	10.16	12.67
2X06P	12.70	15.21
2X07P	15.24	17.75
2X08P	17.78	20.29
2X09P	20.32	22.83
2X10P	22.86	25.37
2X11P	25.40	27.91
2X12P	27.94	30.45
2X13P	30.48	32.99
2X14P	33.02	35.53
2X15P	35.56	38.07
2X16P	38.10	40.61
2X17P	40.64	43.15
2X18P	43.18	45.69
2X19P	45.72	48.23
2X20P	48.26	50.77
2X21P	50.80	53.31
2X22P	53.34	55.85
2X23P	55.88	58.39
2X24P	58.42	60.93
2X25P	60.96	63.47
2X26P	63.50	66.01
2X27P	66.04	68.55
2X28P	68.58	71.09
2X29P	71.12	73.63
2X30P	73.66	76.17
2X31P	76.20	78.71
2X32P	78.74	81.25

Current rating:3A AC,DC
 Voltage rating:250V AC,DC
 Temperature range:-40°C~+105°C
 Contact resistance:20mΩ Max.
 Insulation resistance:1000MΩ Min.
 Withstanding voltage:1500V AC/minute
 Material:PBT30%GF , UL94V-0

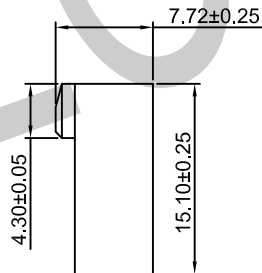
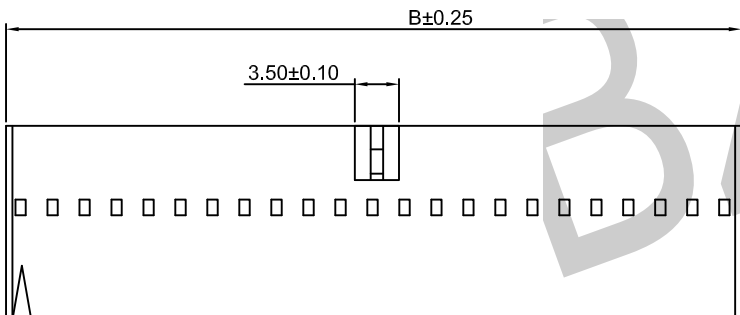
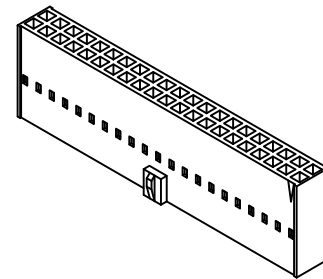
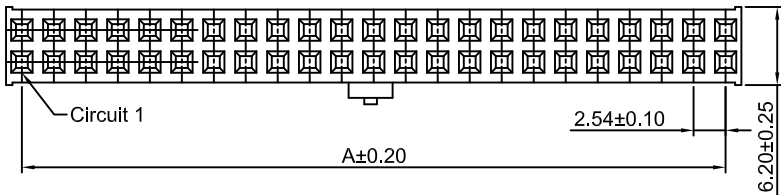

W 254-020-2XX-HM-BK-A-P-000
 WAFFER SERIAL NO.
 254:间距2.54MM
 02:WAFFER TYPE2
 0:UL94V-0
 PIN NO.:
 203:2*3P
 204:2*4P
 ...
 232:2*32P
 PACKING:BAG
 A:PBT
 BK:BLACK
 HM:MALE HOUSING

A0	FIRST RELEASE	Y.L	2019.06.21
REV.	ECN. NO.	APR.	DATE

TOLERANCE UNLESS OTHERWISE SPECIFIED		东莞市柏洲电子有限公司 Dongguan BzooC Electronics, Ltd	
.X± 0.35	X.*± 1.5*	APR. AX.T	TITLE: 2.54MM PITCH DUAL ROW HOUSING TYPE1
.XX± 0.25	.X.*± 1.0*	CHK. Y.L	PART NO.
.XXX± 0.15	.XX.*± 0.5*	DRA. Y.L	PROJ. UNITS. MM SCALE: 1:1 SHEET. 1 / 1 CUSTOMER DRAWING