

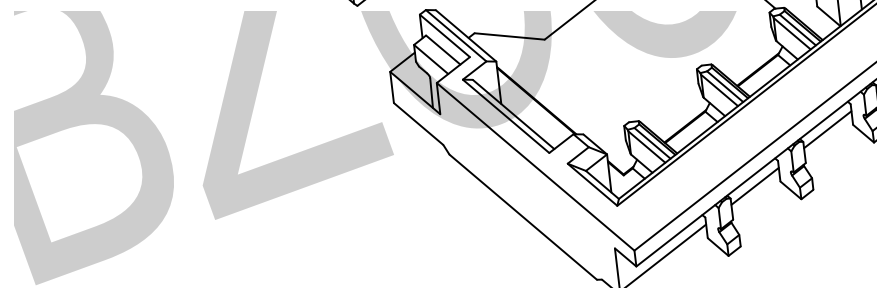

Current rating:1.5A AC,DC  
 Voltage rating:50V AC,DC  
 Temperature range:-40°C~+105°C  
 Contact resistance:20mΩMax.  
 Insulation resistance:100MΩMin.  
 Withstanding voltage:500V AC/minute

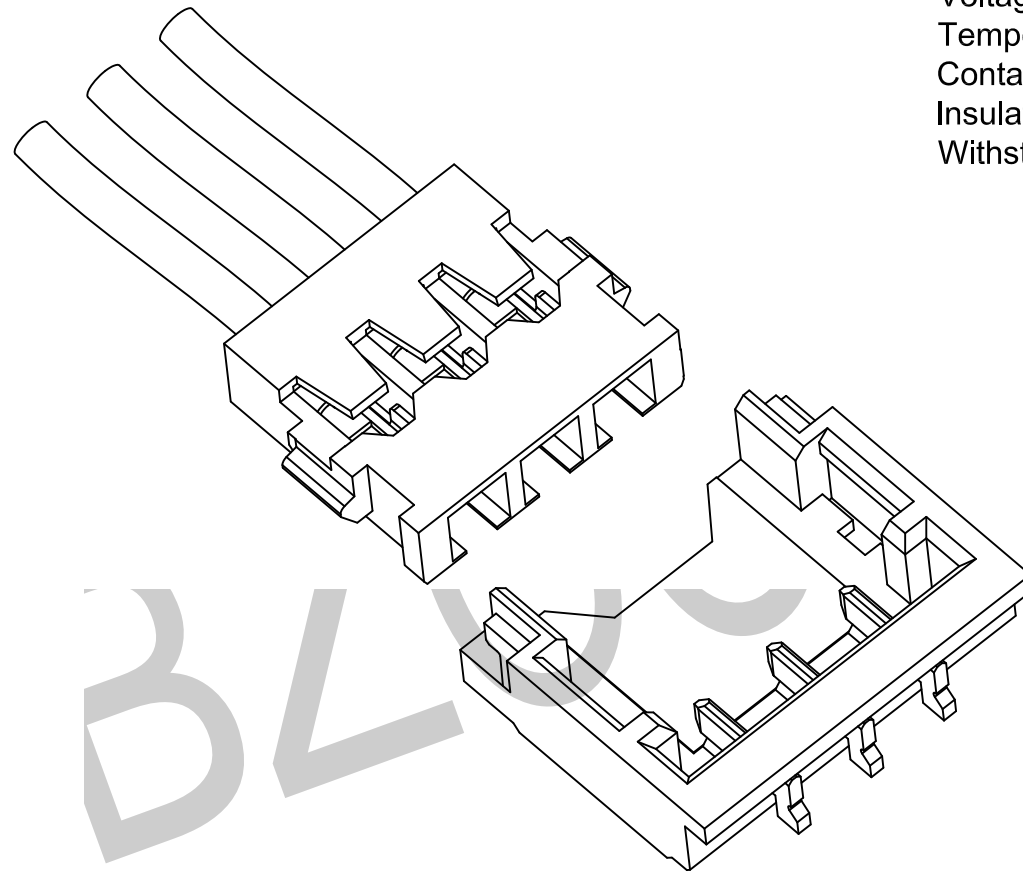

TOLERANCE UNLESS OTHERWISE SPECIFIED		<b>BZOO</b> 东莞市柏洲电子有限公司 Dongguan Bzoo Electronics, Ltd	
.X± 0.35	X.*± 1.5*	APR. AX.T	TITLE: 1.20MM PITCH TYPE1
.XX± 0.25	.X*± 1.0*	CHK. Y.L	PART NO.
.XXX± 0.15	.XX*± 0.5*	DRA. Y.L	UNITS. MM SCALE: 1:1 CUSTOMER DRAWING
PROJ.		SHEET. 1 / 1	

A0	FIRST RELEASE	Y.L	2019.06.21
REV.	ECN. NO.	APR.	DATE



Current rating:1.5A AC,DC  
 Voltage rating:50V AC,DC  
 Temperature range:-40°C~+105°C  
 Contact resistance:20mΩMax.  
 Insulation resistance:100MΩMin.  
 Withstanding voltage:500V AC/minute  
 Wire Range:AWG#30~#36  
 Insulation O.D.:0.38~0.75mm(max)  
 Material:Phosphor Bronze  
 Qty/reel:15,000 PCS

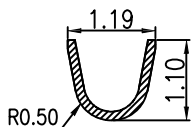
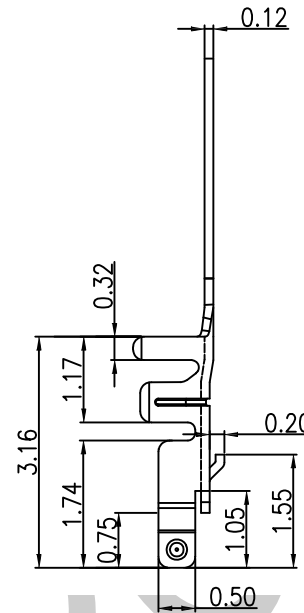
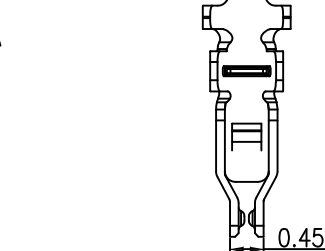
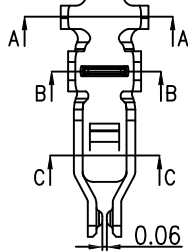
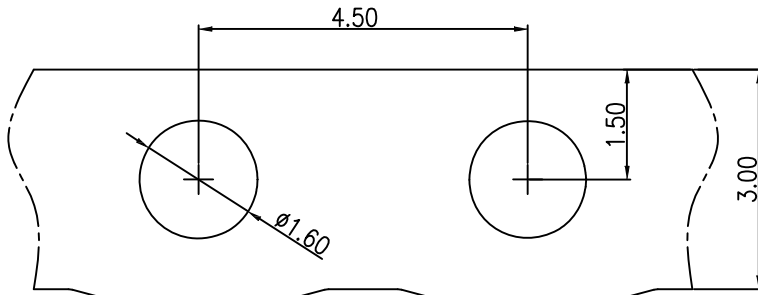

SECTION A-A

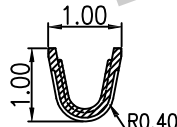

SECTION B-B

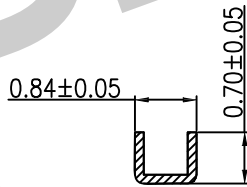

SECTION C-C

WAFER W 120-01F-PDJ-GF-000 SERIAL NO.  
 PITCH 1.20MM GOLD FLASH  
 WAFER TYPE 1 DJ:LOW. PIN  
 F:FEMALE TERMINAL  
 P:PHOSPHOR BRONZE

TOLERANCE UNLESS OTHERWISE SPECIFIED		<b>BZOOC</b> 东莞市柏洲电子有限公司 Dongguan BzooC Electronics, Ltd	
.X± 0.35	X.*± 1.5*	APR. AX.T	TITLE: 1.20MM PITCH CRIMP TERMINAL TYPE1
.XX± 0.25	.X*± 1.0*	CHK. Y.L	PART NO.
.XXX± 0.15	.XX*± 0.5*	DRA. Y.L	PROJ.
A0	FIRST RELEASE	Y.L	2019.06.21
REV.	ECN. NO.	APR.	DATE
		UNITS. MM	SCALE: 1:1
		CUSTOMER DRAWING	
		SHEET. 1 / 1	

A0	FIRST RELEASE	Y.L	2019.06.21
REV.	ECN. NO.	APR.	DATE



Current rating:1.5A AC,DC  
 Voltage rating:50V AC,DC  
 Temperature range:-40°C~+105°C  
 Contact resistance:20mΩMax.  
 Insulation resistance:100MΩMin.  
 Withstanding voltage:500V AC/minute  
 Material:PA10T,UL94V-0

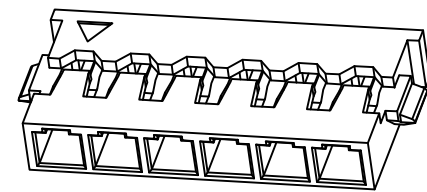
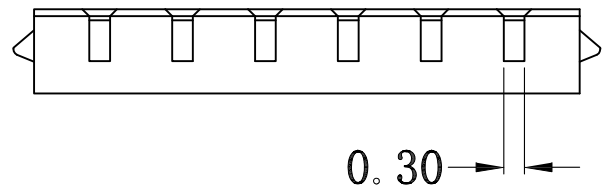

Poles	DIM A	DIM B
2P	1.20	2.60
3P	2.40	3.80
4P	3.60	5.00
5P	4.80	6.20
6P	6.00	7.40
7P	7.20	8.60

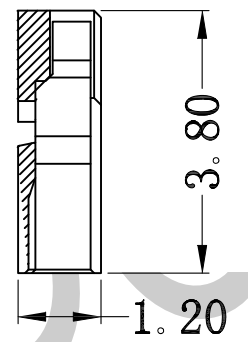
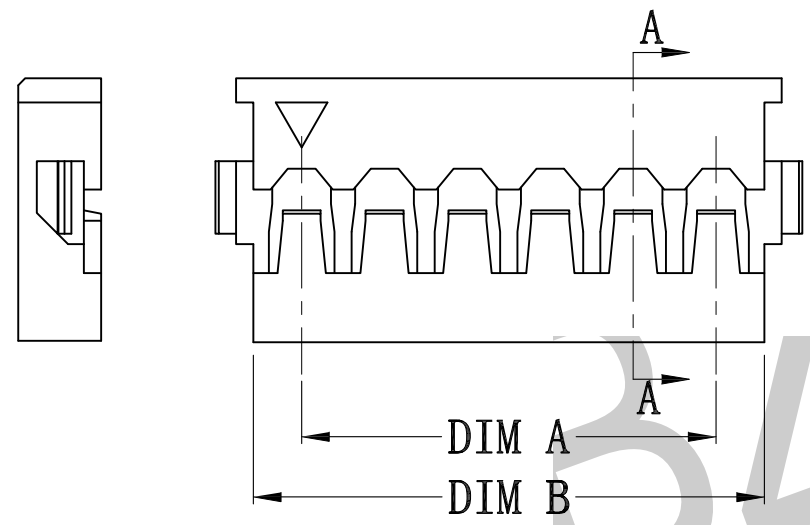

W 120-010-1XX-HM-BK-H-P-000  
 SERIAL NO.  
 PACKING: BAG  
 H: PA10T  
 BK: BLACK  
 HM: MALE HOUSING

WAFER  
 PITCH: 1.2MM  
 WAFER TYPE 1  
 0: UL94V-0  
 PIN NO. :  
 102: 1\*2P  
 103: 1\*3P  
 ...  
 115: 1\*15P

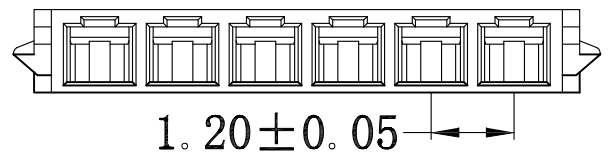

TOLERANCE UNLESS OTHERWISE SPECIFIED		<b>BZOOC</b> 东莞市柏洲电子有限公司 Dongguan BzooC Electronics, Ltd	
.X± 0.35	X.*± 1.5'	APR. AX.T	TITLE: 1.20MM HOUSING TYPE1
.XX± 0.25	.X*± 1.0'	CHK. Y.L	PART NO.
.XXX± 0.15	.XX*± 0.5'	DRA. Y.L	PROJ.
A0	FIRST RELEASE	Y.L	2019.06.21
REV.	ECN. NO.	APR.	DATE
UNITS: MM		SCALE: 1:1	SHEET. 1 / 1
CUSTOMER DRAWING			

A0	FIRST RELEASE	Y.L	2019.06.21
REV.	ECN. NO.	APR.	DATE



Current rating:1.5A AC,DC  
 Voltage rating:50V AC,DC  
 Temperature range:-40°C~+105°C  
 Contact resistance:20mΩMax.  
 Insulation resistance:100MΩMin.  
 Withstanding voltage:500V AC/minute  
 Material:Pin:Phosphor Bronze/Gold over Nickel  
 Insulator:LCP,UL94V-0  
 Solder Tab: Brass/Tin over Nickel

Poles	Dimensions(mm)		
	A	B	C
02	1.20	4.20	2.64
03	2.40	5.40	3.84
04	3.60	6.60	5.04
05	4.80	7.80	6.24
06	6.00	9.00	7.44
07	7.20	10.20	8.64

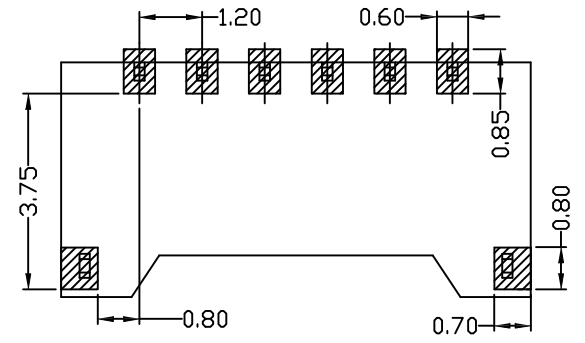

RECOMMENDED PCB LAYOUT  
 GENERAL TOLERANCE:±0.05

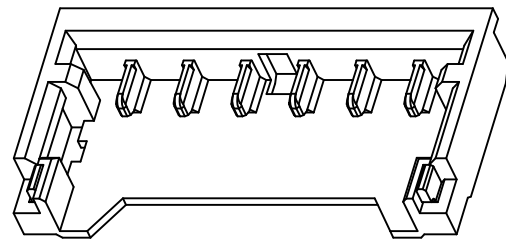

04PIN以上

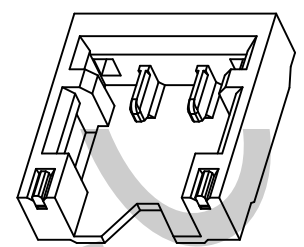
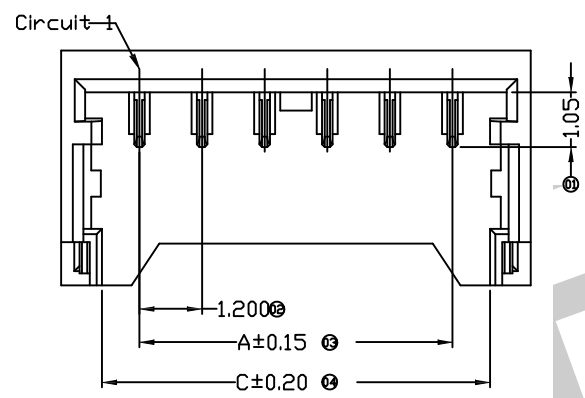

02-03PIN

WAFER: W 120-010-1XX-WRS-SN-F-R-BK-000 SERIAL NO.  
 PITCH: 1.20mm BK: BLACK  
 01: WAFER TYPE1 R: REEL  
 0: UL94V-0 F: LCP  
 PIN: 90° SMT SN: TIN PLATING  
 102: 1\*2P  
 103: 1\*3P  
 .....  
 107: 1\*7P

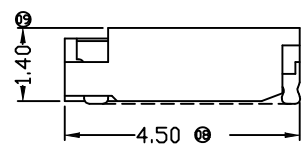
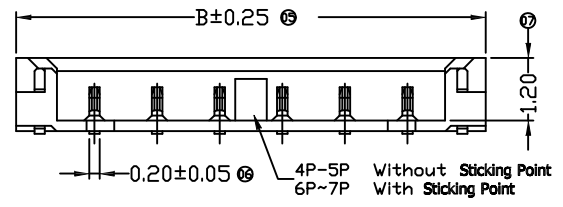

A0	FIRST RELEASE	Y.L	2019.06.21
REV.	ECN. NO.	APR.	DATE

TOLERANCE UNLESS OTHERWISE SPECIFIED		<b>BZOOC</b> 东莞市柏洲电子有限公司 Dongguan BzooC Electronics, Ltd	
.X± 0.35	X.*± 1.5'	APR. AX.T	TITLE: 1.20MM 90° WAFER TYPE1
.XX± 0.25	.X*± 1.0'	CHK. Y.L	PART NO.
.XXX± 0.15	.XX*± 0.5'	DRA. Y.L	PROJ.
		UNITS. MM	SCALE: 1:1
		CUSTOMER DRAWING	
		SHEET. 1 / 1	