

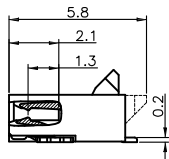

Electrical Characteristics:
 Current rating: 0.4A AC/DC
 Voltage rating: 50V AC/DC
 Temperature range: -25°C~+85°C
 Withstand Voltage: 200V AC/Minute
 Contact Resistance: ≤ 20mΩ
 Insulation resistance: ≥ 500mΩ

Material Description:
 Terminal: Phosphor Bronze Gold-Plated
 Fitting Nail: Phosphor Bronze Gold-plated
 Housing: LCP (UL94V-0)
 Slider: LCP (UL94V-0)

CKTS	DIM A	DIM B	DIM C	DIM D
4P	1.50	2.60	5.50	5.60
5P	2.00	3.10	6.00	6.10
6P	2.50	3.60	6.50	6.60
7P	3.00	4.10	7.00	7.10
8P	3.50	4.60	7.50	7.60
9P	4.00	5.10	8.00	8.10
10P	4.50	5.60	8.50	8.60
11P	5.00	6.10	9.00	9.10
12P	5.50	6.60	9.50	9.60
13P	6.00	7.10	10.00	10.10
14P	6.50	7.60	10.50	10.60
15P	7.00	8.10	11.00	11.10
16P	7.50	8.60	11.50	11.60
17P	8.00	9.10	12.00	12.10
18P	8.50	9.60	12.50	12.60
19P	9.00	10.10	13.00	13.10
20P	9.50	10.60	13.50	13.60
21P	10.00	11.10	14.00	14.10
22P	10.50	11.60	14.50	14.60
23P	11.00	12.10	15.00	15.10
24P	11.50	12.60	15.50	15.60
25P	12.00	13.10	16.00	16.10
26P	12.50	13.60	16.50	16.60
27P	13.00	14.10	17.00	17.10
28P	13.50	14.60	17.50	17.60
29P	14.00	15.10	18.00	18.10
30P	14.50	15.60	18.50	18.60
31P	15.00	16.10	19.00	19.10
32P	15.50	16.60	19.50	19.60
33P	16.00	17.10	20.00	20.10
34P	16.50	17.60	20.50	20.60
35P	17.00	18.10	21.00	21.10
36P	17.50	18.60	21.50	21.60
37P	18.00	19.10	22.00	22.10
38P	18.50	19.60	22.50	22.60
39P	19.00	20.10	23.00	23.10
40P	19.50	20.60	23.50	23.60
41P	20.00	21.10	24.00	24.10
42P	20.50	21.60	24.50	24.60
43P	21.00	22.10	25.00	25.10
44P	21.50	22.60	25.50	25.60
45P	22.00	23.10	26.00	26.10
46P	22.50	23.60	26.50	26.60
47P	23.00	24.10	27.00	27.10
48P	23.50	24.60	27.50	27.60
49P	24.00	25.10	28.00	28.10
50P	24.50	25.60	28.50	28.60
51P	25.00	26.10	29.00	29.10
52P	25.50	26.60	29.50	29.60
53P	26.00	27.10	30.00	30.10
54P	26.50	27.60	30.50	30.60
55P	27.00	28.10	31.00	31.10
56P	27.50	28.60	31.50	31.60
57P	28.00	29.10	32.00	32.10
58P	28.50	29.60	32.50	32.60
59P	29.00	30.10	33.00	33.10
60P	29.50	30.60	33.50	33.60

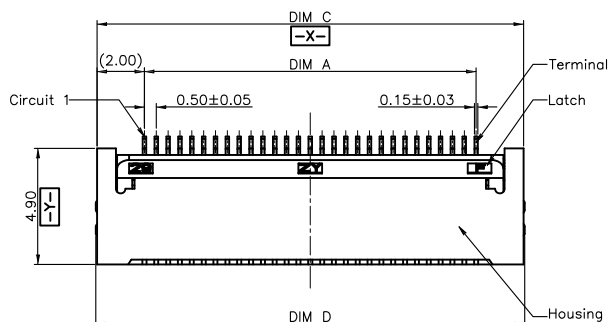

SECTION A-A
SCALE 1:1

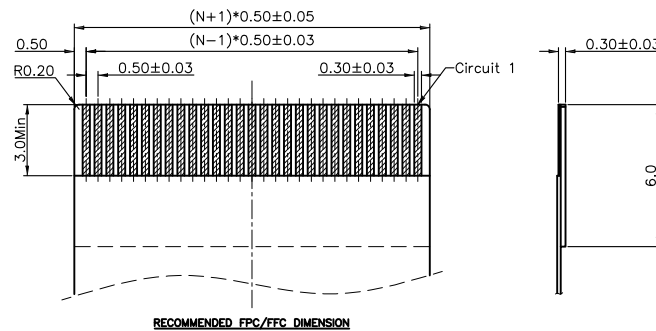

RECOMMENDED FPC/FPC DIMENSION

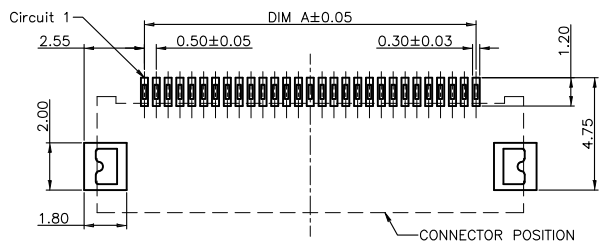
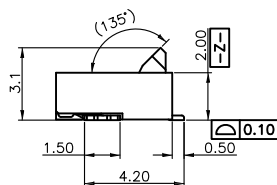
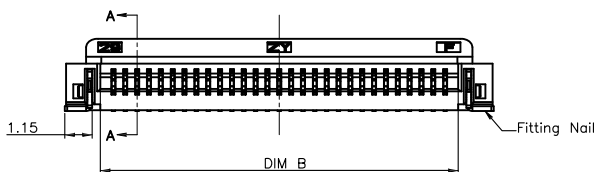

RECOMMENDED P.C.B. PATTERN LAYOUT

FPC: FP 050-020-0XX-WRS-GF-F-X-QHS-000
 流水号
 间距0.5MM
 前插后锁
 塑胶高度: 020:2.0MM
 包装: T: 管装 R: 卷装
 PIN数: 004:4PIN 005:5PIN 060:60PIN
 90° -SMT
 F:LCP
 镀金

TOLERANCE UNLESS OTHERWISE SPECIFIED		BZOO 东莞市柏洲电子有限公司 Dongguan Bzoo Electronics, Ltd	
.X± 0.35	X.'± 1.5'	APR. AX.T	TITLE: 0.5mm FPC 卧贴前插后翻盖 H2.0 带焊片
.XX± 0.25	.X'± 1.0'	CHK. Y.L	PART NO.
.XXX± 0.15	.XX'± 0.5'	DRA. Y.L	PROJ. UNITS: MM SCALE: 1:1 SHEET. 1 / 1
REV.	ECN. NO.	APR.	DATE
A0	FIRST RELEASE	Y.L	2019.06.21

REV.	ECN. NO.	APR.	DATE
A0	FIRST RELEASE	Y.L	2019.06.21



RoHS
Compliant

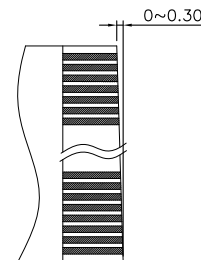
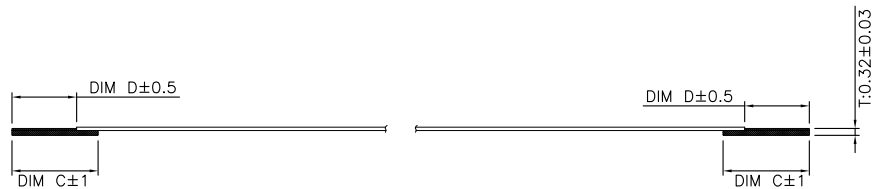
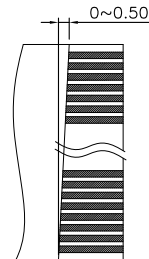
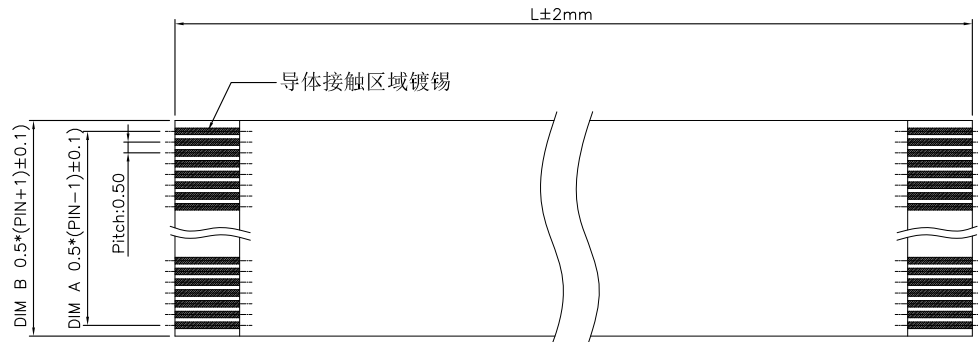

STRUCTURE(结构)		
No.	ITEM (项目)	SPECICATION (规格)
1	INSULATION (胶膜)	UL
		WHITE(白色)
2	SUPPORTING TAPE (补强板)	BLUE(蓝色)
3	CONDUCTOR (导体)	THICKNESS (厚度) 0.035±0.005mm
		WIDTH (宽度) 0.30±0.03mm
4	CONDUCTOR PLATING (导体镀层)	PLATED(电镀 Sn(锡) 40u")

DIMENSION(尺寸)		
1	No.of conductors (导体数目)	N
2	Pitch (间距)	Pitch:0.5mm±0.08
3	Span (总间距)	DIM A:0.5mm*(PIN-1)
4	Width(总宽度)	DIM B:0.5mm*(PIN+1)
5	Insert Thickness (接线端厚度)	T:0.32mm±0.03
6	Strip Length (导体长度)	DIM D:3mm
7	Supporting Tape Length (补强板长度)	DIM C:4mm

FF 050-XXX-T-34-100-WE-0-P-000

FFC排线
 间距: 050:0.5mm
 PIN数: 004:4PIN
 005:5PIN

 T:两端导体同面
 34:导体长度3mm/补强板长度4mm

流水号
 P:袋装
 0:不包布
 绝缘胶膜颜色:
 WE:白色
 总长度:
 100:L:100mm
 长度可定制

TOLERANCE UNLESS OTHERWISE SPECIFIED				BZOOC 东莞市柏洲电子有限公司 Dongguan BzooC Electronics, Ltd	
.X± 0.35	X.*± 1.5'	APR. AX.T	TITLE: 0.5FFC排线 同向 3/4 白膜		
.XX± 0.25	.X*± 1.0'	CHK. Y.L	PART NO.		
.XXX± 0.15	.XX*± 0.5'	DRA. Y.L	PROJ.	UNITS. MM SCALE: 1:1	SHEET. 1 / 1
REV.	ECN. NO.	APR.	DATE	CUSTOMER DRAWING	

A0	FIRST RELEASE	Y.L	2019.06.21
REV.	ECN. NO.	APR.	DATE



RoHS
Compliant

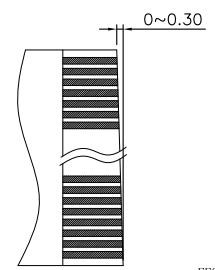
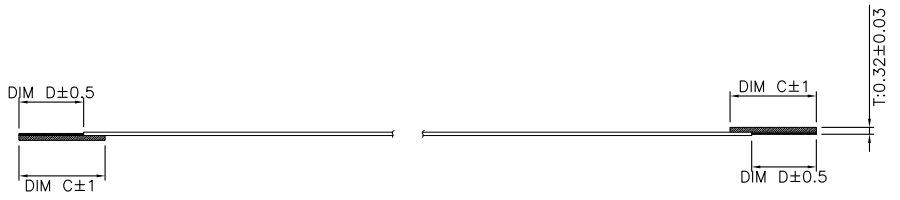
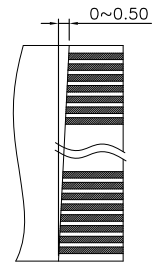
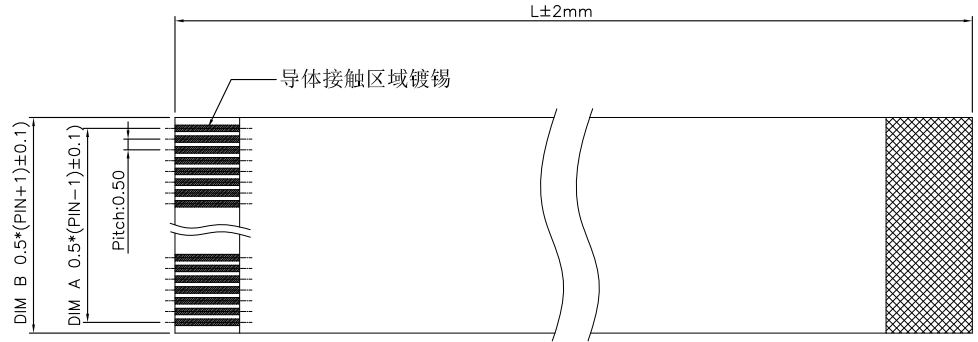

STRUCTURE(结构)		
No.	ITEM (项目)	SPECICATION (规格)
1	INSULATION (胶膜)	UL
		WHITE(白色)
2	SUPPORTING TAPE (补强板)	BLUE(蓝色)
3	CONDUCTOR (导体)	THICKNESS (厚度) 0.035±0.005mm
		WIDTH (宽度) 0.30±0.03mm
4	CONDUCTOR PLATING (导体镀层)	PLATED(电镀) Sn(锡) 40u"

DIMENSION(尺寸)		
1	No.of conductors (导体数目)	N
2	Pitch (间距)	Pitch:0.5mm±0.08
3	Span (总间距)	DIM A:0.5mm*(PIN-1)
4	Width(总宽度)	DIM B:0.5mm*(PIN+1)
5	Insert Thickness (接线端厚度)	T:0.32mm±0.03
6	Strip Length (导体长度)	DIM D:3mm
7	Supporting Tape Length (补强板长度)	DIM C:4mm

FF 050-XXX-F-34-100-WE-0-P-000

FFC排线
 间距: 050:0.5mm
 PIN数: 004:4PIN
 005:5PIN

 F:两端导体反面
 34:导体长度3mm/补强板长度4mm

流水号
 P:袋装
 0:不包布
 绝缘胶膜颜色:
 WE:白色

总长度:
 100:L:100mm
 长度定制

TOLERANCE UNLESS OTHERWISE SPECIFIED				BZOOC 东莞市柏洲电子有限公司 Dongguan BzooC Electronics, Ltd	
.X± 0.35	X.'± 1.5'	APR. AX.T	TITLE: 0.5FFC排线 反向 3/4 白膜		
.XX± 0.25	.X'± 1.0'	CHK. Y.L	PART NO.		
.XXX± 0.15	.XX'± 0.5'	DRA. Y.L	PROJ.	UNITS. MM	SCALE. 1:1
REV.	ECN. NO.	APR.	DATE	CUSTOMER DRAWING	
A0	FIRST RELEASE	Y.L	2019.06.21	SHEET. 1 / 1	